





Welcome to Mackintosh.

You hold in your hands everything you need to realise your ideal kitchen space. A place to inspire you, to define you, to shape how you live. If you're looking to lift your home beyond the ordinary, to make it truly yours, then take a look inside.



20 YEAR GUARANTEE
on all cabinets, hinges & drawer boxes

Our kitchens are made for life. Not just that they last a lifetime, although our 20 year guarantee will assure you of that, but they're made to be lived in.

We guarantee that your kitchen cabinets will be free from defects in materials and workmanship, or else we'll repair or replace free of charge, for a full 20 years.

Plus we also cover your doors and selected accessories for 15 years, so you can enjoy your new kitchen knowing you're taken care of by our guarantee.

CONTENTS

A TRUE CRAFTSMAN	6
BRITISH DESIGN	7
IDEAS & ADVICE	
TEXTURE & PATTERN	8
MAKE YOUR MARK	10
THE KITCHENS	
HANDLELESS	14
MODERN RANGE	34
SHAKER RANGE	85
TRADITIONAL RANGE	115
OPTIONS & ACCESSORIES	
DOOR COLLECTION	140
PAINTED OPTIONS	144
CABINETS	146
DRAWERS	148
HANDLES	150
SINKS	152
TAPS	153
WORKTOPS	154
LIGHTING	158
DESIGN FEATURES	164
ORGANISATION	168
CLEVER STORAGE	170
PLANNING	174
FAQS	176
INDEX	177
KITCHEN SPECIFICATIONS	178

A TRUE CRAFTSMAN

knows his heritage, his place in the bigger picture. He knows that every technique he uses is the cumulation of centuries of knowledge passed down and adapted through the generations.

That's why we're proud to use the most innovative techniques and technologies in the production of our kitchens. Along with the finest materials and components. Our aim is always to make the best kitchens possible. Simple as that.



BRITISH DESIGN

British design is famous the world over. When you choose a Mackintosh kitchen, you bring the best of British into your home. That's because our range of premium quality kitchens are built using the finest materials from around the world, manufactured right here in our purpose-built factory in the heart of Yorkshire.

We craft each and every kitchen with love, skill and attention. Our rigid cabinets are made to order using traditional glue and dowel construction and assembled under pressurised conditions. Meaning squarer, stronger cabinets with no visible screws or fixings.

The result is a range of kitchens we're proud to call our own.
And we're sure you will be too.



BRITISH QUALITY

COMBINING TRUE BRITISH CRAFTSMANSHIP
WITH CONTEMPORARY DESIGN.

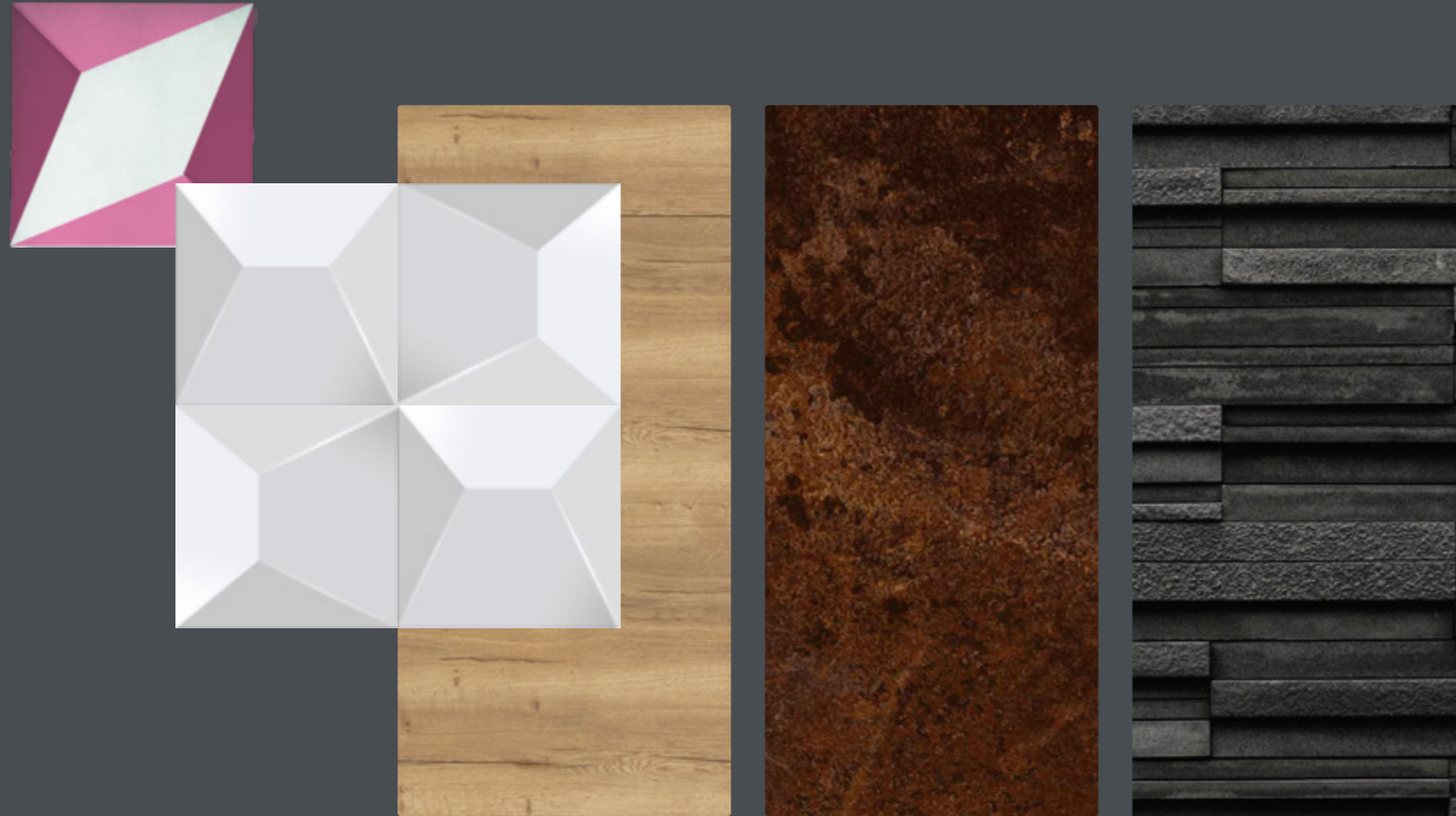

TEXTURE

Textures deepen and define a space. Natural woodgrains and fabrics will bring homeliness, metals and marble a contemporary feel. Make a feature of a tiled splashback or contrast a glossy finish with soft furnishings.

PATTERN

As pattern seeking creatures, we take joy in finding and contrasting them. But only so far. As with patterns in music, there needs to be harmony for the effect to be pleasing. Use pattern sparingly in your kitchen with a few subtle contrasts, and they will sing.



MAKE YOUR MARK

Your new kitchen is the room you'll spend most of your time in, so it needs to be as much an extension of yourself as it is a working space. We'll provide the units, fixtures and fittings to your specification. But the rest is up to you.

Choose your wall paint, appliances, accessories, art, soft furnishings and the like in harmony with the kitchen you've created. Be bold and make it yours.



Our instagram feed is packed full of inspiration, from accessories to wall colour. Take a look @mackintoshkitchens



1 Play with lighting, both natural and artificial. Use it to accentuate texture, to highlight colour, or as a feature in itself.

2 Use accessories and artwork to bring bursts of colour that can easily be changed with shifting trends, or as your own tastes develop.

ADDING MORE COLOUR



3 An accent isn't an accent if there are lots of them. Pick a contrasting colour, use it sparingly. Then it'll pop.

4 Use texture to deepen your colour scheme. By changing how light hits a surface, you'll subtly introduce a whole new set of shades to your palette.





WE WORK BETTER UNDER PRESSURE

All our cabinets are perfectly pressed together under controlled conditions so they're squarer, straighter and stronger. Which in turn means they fit better, last longer and are more than ready to take what everyday life throws at them.

MACKINTOSH®

NOTHING TO SEE HERE

All our cabinets are made to order, using a glue and dowel construction which leaves no visible screws or fixings. The only holes we drill are custom to your specification, resulting in a flawless finish inside and out.





Our handleless range will bring your kitchen bang up to date. You'll find the latest storage innovations cleverly hidden within elegant, flowing forms. Experience the simplicity and clarity of minimalism, without sacrificing any mod cons.

20 YEAR GUARANTEE
on all cabinets, hinges & drawer boxes

THE RANGE

OBLIQUE PAINTED SKY & WHITE	20
OBLIQUE GLOSS WHITE	22
INSET CHIC FJORD & DARK BLUE	24
INSET LINEAR LUSTRE METALLIC, CHIC GRAPHITE & DUSK GREY	26
INSET LINEAR PAINTED LIMESTONE & ANTHRACITE	28
INSET CHIC COPPER & BELLATO GREY	30
INSET METRICA GLOSS WHITE	32

GET INTO THE GROOVE

(WITH HANDLELESS)

Early variations of the handleless door started popping up in the swinging sixties, featuring an aluminium groove that sparkled beneath the orange Formica worktops. The kitchen was becoming a space to entertain, and jagged aluminium gullies were the price to be paid for getting down to The Beatles in amongst the crockery.

Before you knew it, every shindig was starting and ending in the kitchen. Turn to today and our handleless range sets the bar for entertaining spaces everywhere, with minimalist styling and a range of features that make your kitchen the place to be. So you can focus on the important things. Like getting your groove on.

HANDLELESS KITCHENS

Minimalism is always in style, so we offer three different handleless options to maintain those clean lines you want in your sleek new kitchen. Discover Oblique, Touch and Inset – solutions you'll fall in love with.

OBLIQUE

With a smart chamfered edge on the reverse of the frontal providing plenty of grip, Oblique doors bring crisp lines and angular beauty.



Stainless Steel



Cashmere



Copper



Dark Grey



Limestone



White



TOUCH

With our Touch range, doors and drawers are opened intuitively by touch with no need for handles.

One or two units – like appliances and pull-out larders – do still require handles. Luckily, we've got a discrete solution for every possibility, so your handleless kitchen will stay that way.

INSET

Inset allows all of our slab doors to be designed in a handleless way, featuring a discreet handle on the reverse of the door – almost impossible to notice but effortless to use.



HANDLELESS

OBLIQUE
PAINTED SKY & WHITE

Painted door with a chamfered edge.

21

21 PAINTED COLOURS
See page 144 to see our full palette.





OBLIQUE
GLOSS WHITE

Lacquered gloss white door
with a chamfered edge.



ACCESSORISE

Don't be afraid to add colour. Accessories are a great way of changing the accents of your space without committing to a permanent scheme. A splash of colour in the right place can work wonders. And you can always change it tomorrow.



INSET CHIC FJORD & DARK BLUE

Slab door in a smooth finish.

HANDLELESS



INSET LINEAR
LUSTRE METALLIC
CHIC GRAPHITE
& DUSK GREY

Slab doors with a high gloss finish
and smooth finish.

HANDLELESS

INSET LINEAR PAINTED LIMESTONE & ANTHRACITE

Slab door in a smooth painted finish.

21

21 PAINTED COLOURS
See page 144 to see our full palette.





INSET CHIC

COPPER & BELLATO GREY

Slab door in a brushed copper and concrete effect finish.



INSET METRICA
GLOSS WHITE
Slab door in a gloss finish.

MODERN KITCHENS

Our contemporary designs are as adaptable as you are. From a recess for your coffee machine, to a slot for that spiraliser you occasionally use, we've got an innovation for every want.

Perfect for quiet morning espressos, or raucous evenings with friends. Our modern kitchens are cleverly designed, utterly beautiful and full of surprises.

20 YEAR GUARANTEE
on all cabinets, hinges & drawer boxes

THE RANGE

AUTOGRAPH PAINTED HEATHER & GRAPHITE	40
WOODGRAIN ATRIUM GREY & CHIC GRAPHITE	45
CHIC IVORY & CASHMERE, LIMESTONE & LIGHT GREY	46
INTEGRAL GLOSS CASHMERE	48
INTEGRAL GLOSS WHITE	50
INTEGRAL GLOSS LIGHT GREY	52
INTEGRAL GLOSS LIMESTONE	54
INTEGRAL GLOSS ANTHRACITE	55
INTEGRAL GLOSS GREY	56
INTEGRAL GLOSS IVORY	57
INTEGRAL PAINTED IVORY & GREEN	58
METRICA GLOSS LIGHT GREY	60
METRICA GLOSS CASHMERE	62
METRICA GLOSS WHITE	64
LINEAR GLADSTONE OAK	68
LINEAR SAND OAK	70
LINEAR WHITE OAK	72
FRESCO IVORY & TRUFFLE	74
SHEER GLOSS LIMESTONE	76
SHEER GLOSS IVORY	78
LINEAR PAINTED SAGE GREY & IVORY	80
LINEAR BELLATO GREY	82
LINEAR SATIN WHITE	83



HERE'S TO THE 'ISMS.'

Modernism in its various strands gave us cubism, surrealism, post-impressionism, the list goes on (and on). Appearing at the turn of the 20th century, the modernists believed in simplified forms, streamlined functionality and the reconciliation between manufacturing and the individual artistic spirit. Just like us.

So if you're after a little 'ism', you'll find it right here, in one of our modern kitchens.





Sinks can make dramatic focal points in their own right. Stainless steel sinks for example make great contemporary focal points. Take a look at our full range of sink options. See page 152



MODERN

AUTOGRAPH PAINTED
HEATHER & GRAPHITE

Slab door with a recessed handle in a smooth Graphite & Heather painted finish.



21 PAINTED COLOURS
See page 144 to see our full palette.



WOODGRAIN
ATRIUM
GREY & CHIC
GRAPHITE

Slab doors in a smooth and high gloss finish.



CHIC
IVORY & CASHMERE 1
LIMESTONE 2
LIGHT GREY 3
Slab door in a smooth finish.



INTEGRAL GLOSS
CASHMERE

Gloss lacquered door in a cashmere finish with an integrated pull handle.



INTEGRAL GLOSS WHITE

Gloss lacquered door in a white finish
with an integrated pull handle.





INTEGRAL GLOSS
LIGHT GREY

Gloss lacquered door in a light grey finish
with an integrated pull handle.



INTEGRAL GLOSS
LIMESTONE

Gloss lacquered door in a limestone finish with an integrated pull handle.



INTEGRAL GLOSS
ANTHRACITE

Gloss lacquered door in an anthracite finish with an integrated pull handle.



INTEGRAL GLOSS
GREY

Gloss lacquered door in a grey finish with an integrated pull handle.



INTEGRAL GLOSS
IVORY

Gloss lacquered door in an ivory finish with an integrated pull handle.



INTEGRAL PAINTED
IVORY & GREEN

Painted door with an integrated pull handle.



21 PAINTED COLOURS
See page 144 to see our full palette.





METRICA GLOSS
LIGHT GREY
Slab door in a gloss light grey finish.



METRICA GLOSS
CASHMERE

Slab door in a gloss cashmere finish.





**METRICA GLOSS
WHITE**

Slab door in a gloss white finish.

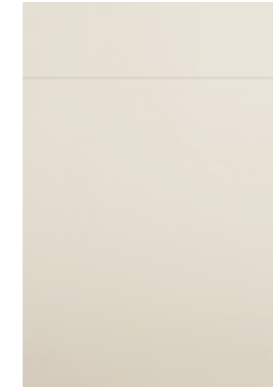

GLOSS STONE

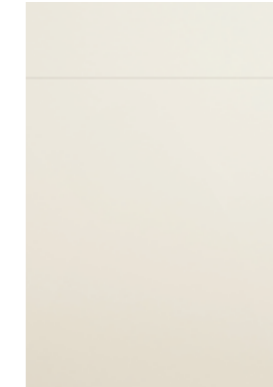

GLOSS IVORY

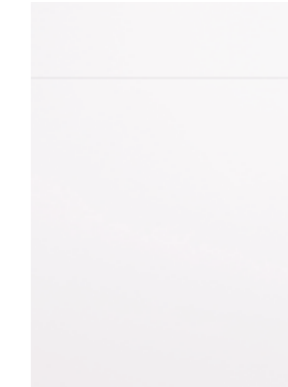

GLOSS WHITE

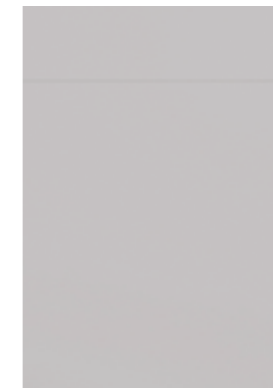

GLOSS GREY

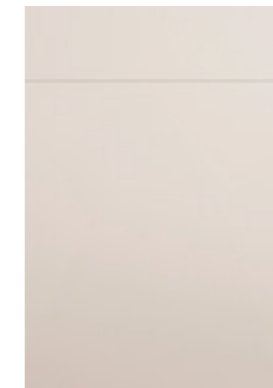

GLOSS CASHMERE

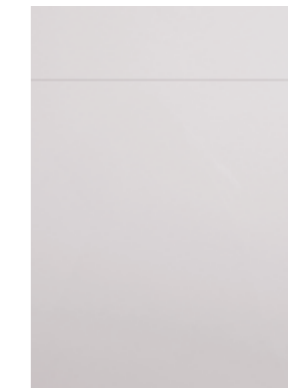

GLOSS LIGHT GREY

THE ONLY THING
I LIKE BETTER THAN
TALKING ABOUT
FOOD IS EATING.

JOHN WALTERS

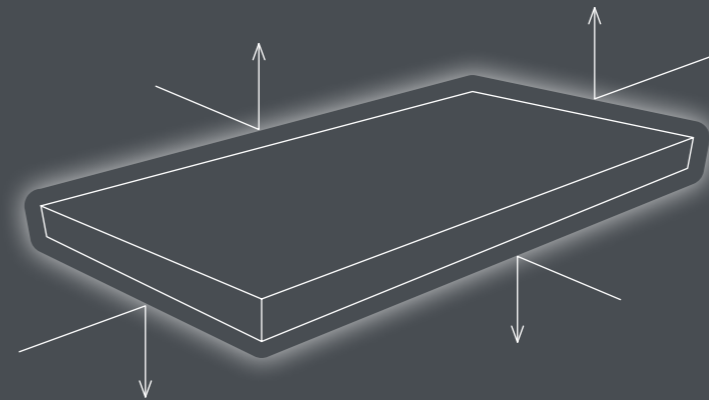

OUR
KITCHENS
HAVE
THE
EDGE.
LITERALLY.

Our cabinets aren't just protected where you can see, but where you can't too - with all-round edging to keep moisture out.



SCAN VIA INSTAGRAM
AND SEE OUR KITCHENS
COME ALIVE.



20 YEAR GUARANTEE
on all cabinets, hinges & drawer boxes

mackintoshkitchens.co.uk





LINEAR
GLADSTONE OAK

Slab door in a woodgrain Gladstone Oak finish.



LINEAR
SAND OAK

Slab door in woodgrain Sand Oak finish.



LINEAR DOORS

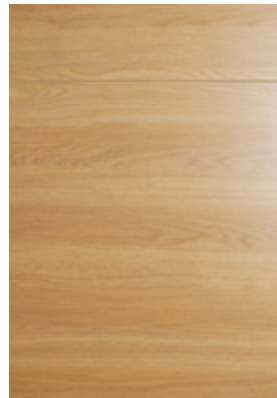

LISSA OAK

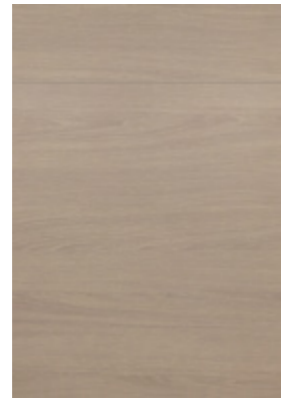

SAND OAK

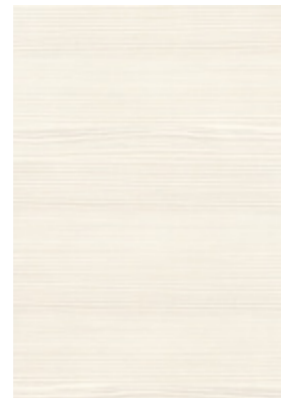

WHITE AVOLA

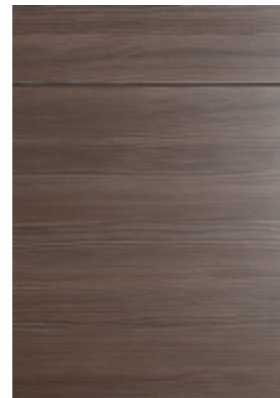

BROWN GREY AVOLA

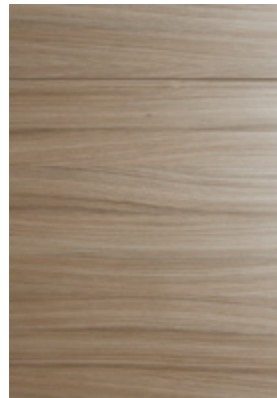

DRIFTWOOD

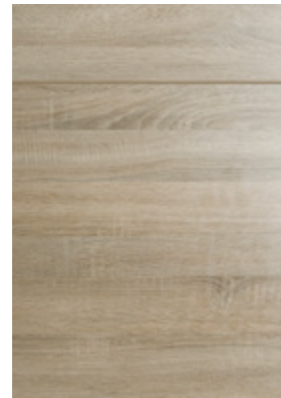

BARDOLINO OAK

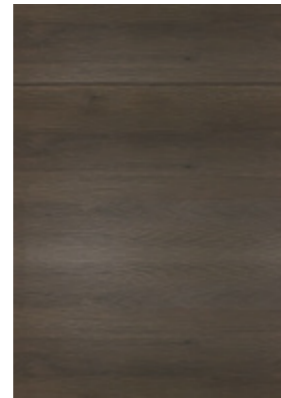

GLADSTONE OAK

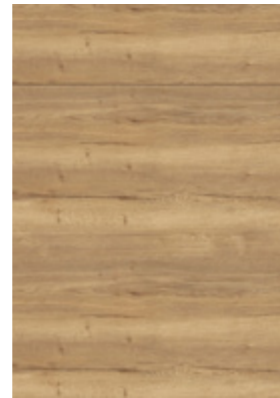

NEW ENGLAND OAK



GREY NEBRASKA OAK

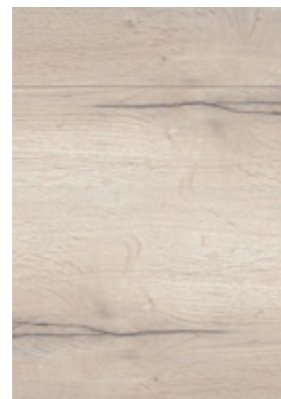

WHITE OAK



ATRIUM GREY



LINEAR
WHITE OAK

Slab door in a White Oak finish.

FRESCO DOORS

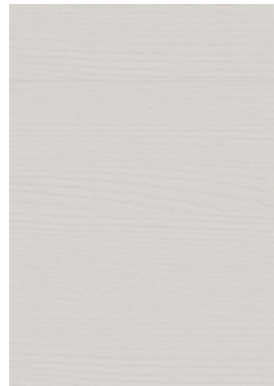

GREY

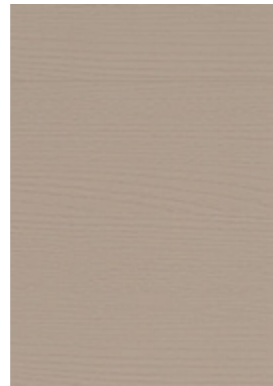

TRUFFLE

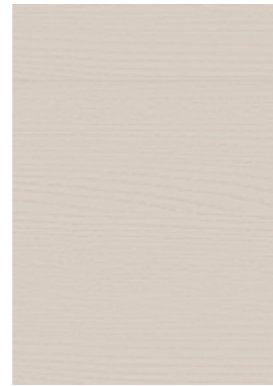

CASHMERE

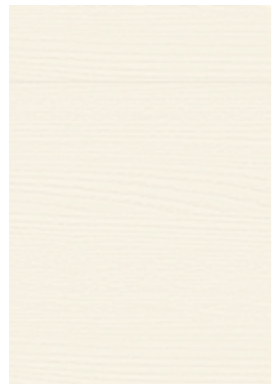

IVORY



ANTHRACITE



FRESCO
IVORY & TRUFFLE

Slab door in a textured finish.



SHEER GLOSS
LIMESTONE

Slab door in a limestone finish.

SHEER DOORS

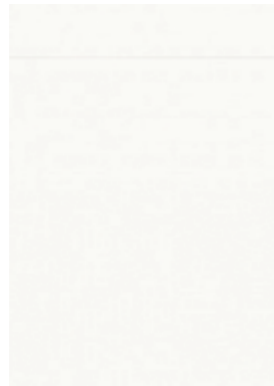

GLOSS WHITE



GLOSS IVORY

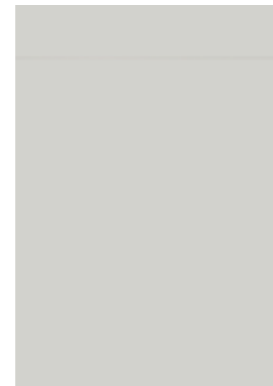

GLOSS LIGHT GREY

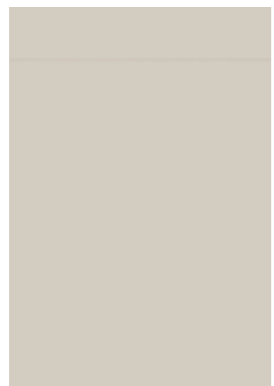

GLOSS CASHMERE

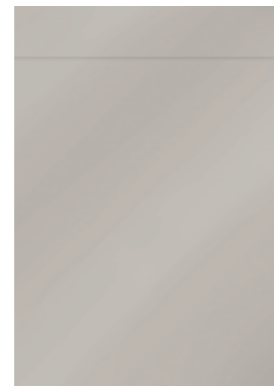

GLOSS LIMESTONE



SHEER
GLOSS IVORY

Slab door in a gloss finish.



LINEAR PAINTED
SAGE GREY & IVORY

Slab door in a painted matt finish.



21 PAINTED COLOURS
See page 144 to see our full palette.





**LINEAR
BELLATO GREY**

Slab door in a concrete effect finish.



**LINEAR
SATIN WHITE**

Slab door in a matt white finish.



20 YEAR GUARANTEE
on all cabinets, hinges & drawer boxes

SHAKER

Utility and simplicity, the core design pillars of the Shakers of New England. You'll find them here upholding elegant modern styling.

Our Shaker range couples design that has stood the test of time with contemporary touches that bring the feel of a modern kitchen.

THE RANGE

NOUVEAU PAINTED INDIGO BLUE & LIMESTONE	88
NOUVEAU WHITE & LIGHT GREY	92
TREND PAINTED SAGE GREY & IVORY	94
TREND IVORY	96
SAVOY PAINTED LIMESTONE & ANTHRACITE	98
TIMELESS PAINTED LIGHT GREY	100
INTEGRAL SHAKER GLOSS WHITE	102
PAINTED WOOD SHAKER IVORY & HICKORY	104
CHAMFERED PAINTED IVORY	106
GLOSS STONE SHAKER	107
TIMBER SAND OAK SHAKER	110
TIMBER LISSA OAK SHAKER	111
TREND IVORY SHAKER	112
TREND LISSA OAK	113
TREND SAND OAK	113

CURIOUS?

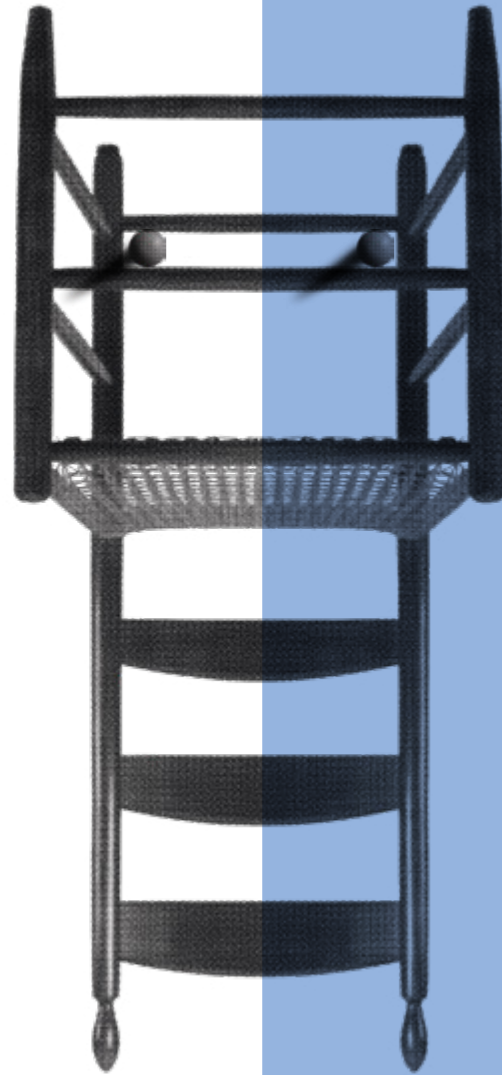

Simple is beautiful. Scandinavians call it Lagom – the Japanese have Shibui, meaning an appreciation of the beauty of silence and subtlety.

For the Shakers of New England, minimalism was a virtue. To craft something useful was considered a form of prayer. That's why our Shaker range strives to achieve beauty through inspired utility.



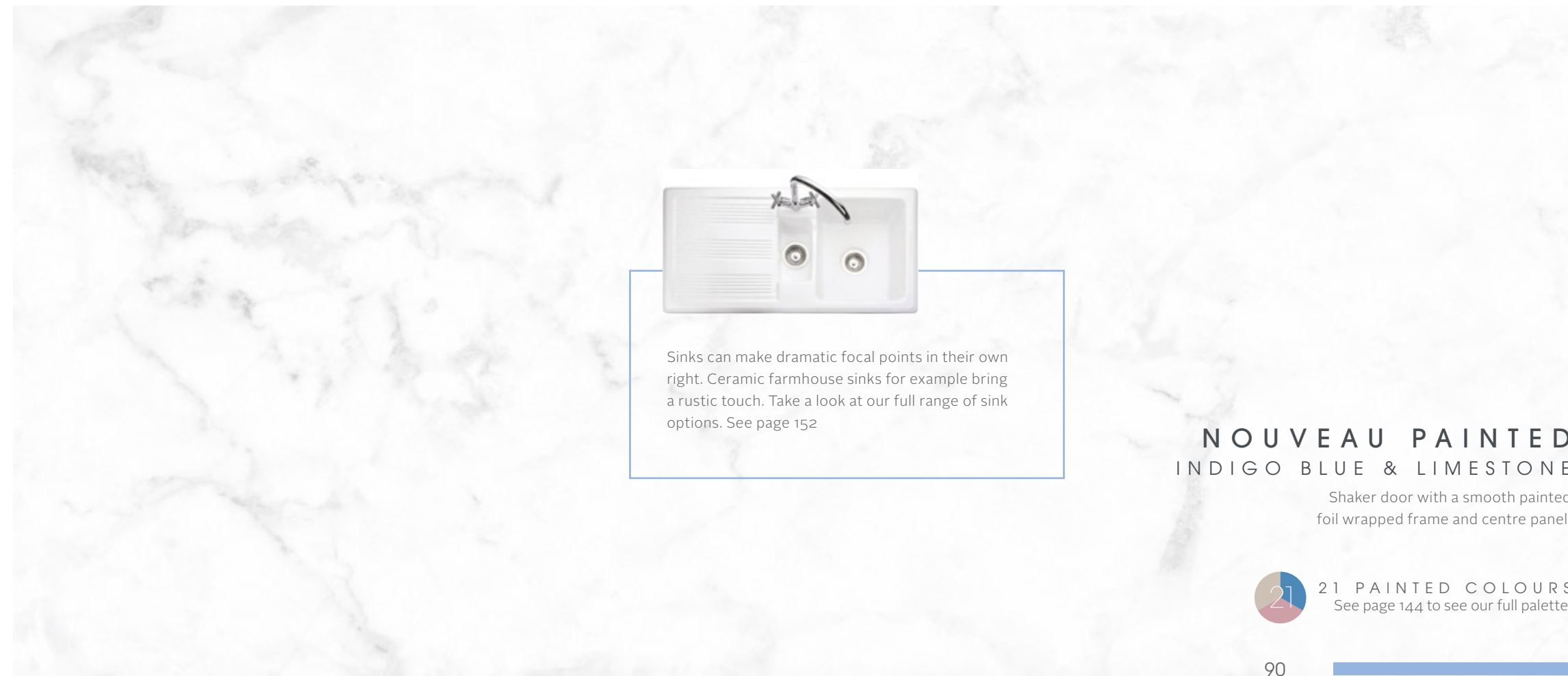

Sinks can make dramatic focal points in their own right. Ceramic farmhouse sinks for example bring a rustic touch. Take a look at our full range of sink options. See page 152

NOUVEAU PAINTED INDIGO BLUE & LIMESTONE

Shaker door with a smooth painted foil wrapped frame and centre panel.

21 PAINTED COLOURS
See page 144 to see our full palette.



COLOUR KEY

The below symbol indicates that the item you're looking at is available in our range of 21 stunning colours.

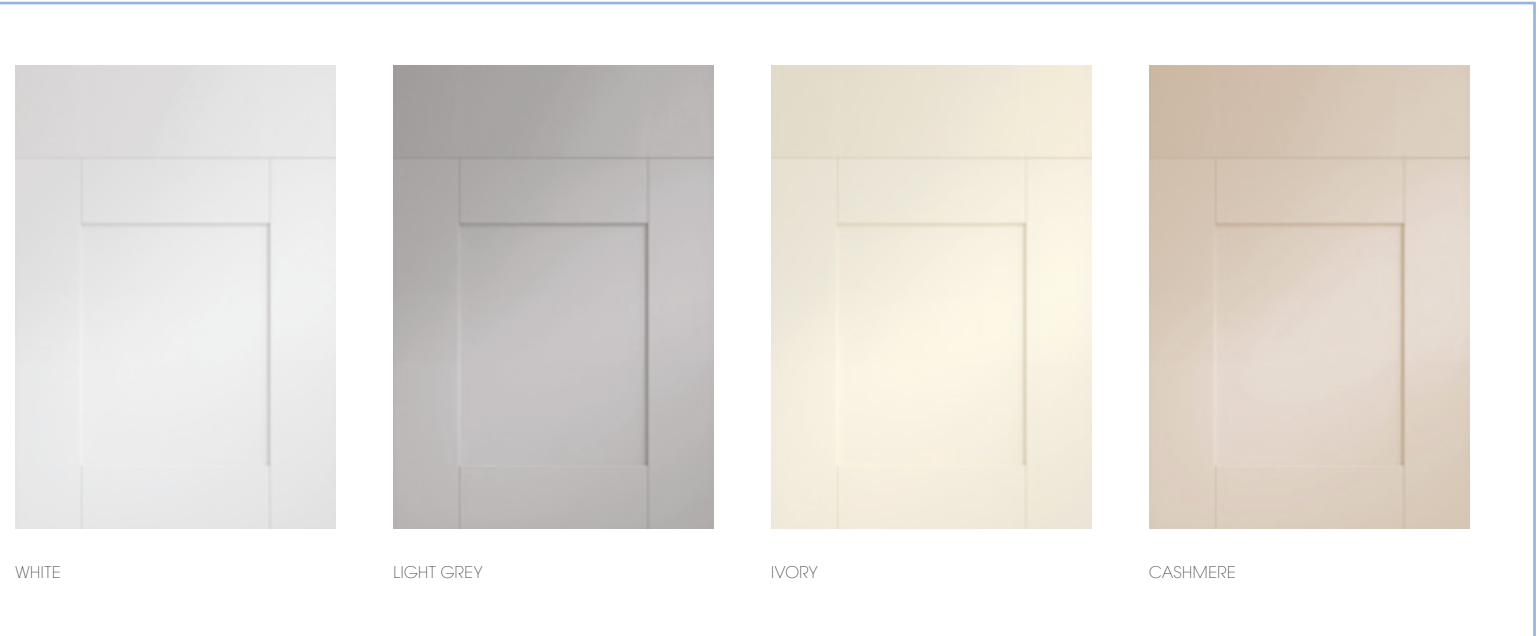
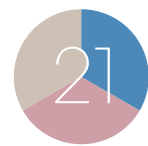

WHITE

LIGHT GREY

IVORY

CASHMERE

NOUVEAU
 WHITE & LIGHT GREY
 Shaker door with a smooth painted-effect finish.



TREND PAINTED
SAGE GREY & IVORY

Shaker door with a painted foil wrapped frame and centre panel with a woodgrain finish.



21 PAINTED COLOURS
See page 144 to see our full palette.





TREND IVORY

Shaker door with an ivory woodgrain effect finish.



SAVOY PAINTED
LIMESTONE &
ANTHRACITE

Shaker door with a recessed handle
in a smooth painted finish.



21 PAINTED COLOURS
See page 144 to see our full palette.



**TIMELESS
PAINTED
LIGHT GREY**

Shaker door with a smooth painted frame and centre panel.

21 PAINTED COLOURS
See page 144 to see our full palette.





**INTEGRAL
SHAKER
GLOSS WHITE**

Shaker style door with integrated pull handle in a gloss white finish.



**PAINTED
WOOD SHAKER
IVORY & HICKORY**

Shaker door with a painted solid timber frame and veneered centre panel.



21 PAINTED COLOURS
See page 144 to see our full palette.



CHAMFERED PAINTED IVORY

Shaker door featuring chamfered beading,
in a painted solid ash frame.

21 PAINTED COLOURS
See page 144 to see our full palette.



GLOSS STONE SHAKER

Shaker door with a gloss stone finish.

WE SEE THE

W   D

FOR THE TREES.

Yes we focus intensely on the tiny details of your new kitchen, but that doesn't mean we forget the bigger picture. All our wood is sourced from responsibly managed forests and we're very proud to have been awarded the FSC® Chain of Custody Certification.

MACKINTOSH®



NEW FINISHES & TEXTURES.

GREY ON GREY.

Graphite cabinets can be matched with graphite frontals, drawers and wirework for a fully coordinated look.

Go to page 170 to view our clever storage solutions in graphite.



LEMANS CORNER STORAGE SYSTEM:

Awarded the Red Dot Design for outstanding design achievements.

See P170



reddot design award

60 WORKTOP OPTIONS

See P154



**TIMBER SAND
OAK SHAKER**

Shaker door with a solid timber frame and veneered centre panel in sand oak.

110



**TIMBER LISSA
OAK SHAKER**

Shaker door with a solid oak frame and veneered centre panel in lissa oak.

111



1



2



3

1. IVORY SHAKER
Shaker door with a smooth matt ivory finish.

2. TREND LISSA OAK
Shaker door with a Lissa Oak woodgrain finish.

3. TREND SAND OAK
Shaker door with a Sand Oak woodgrain effect finish.



TRADITIONAL

Traditional kitchens feature the kind of touches that harken back to a time when craftsmen competed for trade with skill and invention.

Their artisan spirit flows through every aspect of our traditional range, from mantels and pilasters to bevelled doors and ceramic tap handles.

THE RANGE

HARMONY PAINTED TURQUOISE & HEATHER	118
MANOR HOUSE PAINTED HEATHER, SLATE & LIGHT GREY	122
FLUTE IVORY	126
EDWARDIAN PAINTED LIGHT GREY	128
MINSTER PAINTED BLUSH & SLATE	130
FRAMED PAINTED IVORY	132
SCULPTURED PAINTED CASHMERE	134
SHIRES PAINTED LIGHT BLUE & WHITE	136
REGENT IVORY	137

20 YEAR GUARANTEE
on all cabinets, hinges & drawer boxes

CARRYING THE MANTEL



Since Prometheus stole fire from the Gods it's been keeping us alive. We liked it, so we brought it inside. Then we decorated around it to show it off. We sang songs about burning rings and Norwegian wood. Then at some point, we stopped needing it. But we missed it, so we kept the surround, kept decorating it and passing it down through the years. These days you can have one kept over your cooker, so when you spark the hob up it takes you back to where it all started.

Thanks Prometheus.





TRADITIONAL

**HARMONY
PAINTED**
TURQUOISE & HEATHER

In-frame shaker door with a smooth painted turquoise & heather finish.



21 PAINTED COLOURS
See page 144 to see our full palette.



TRADITIONAL

**MANOR HOUSE
PAINTED**
HEATHER, SLATE &
LIGHT GREY

Shaker style door featuring an inner beading with a painted solid timber frame and veneered centre panel.



21 PAINTED COLOURS
See page 144 to see our full palette.



MIX & MATCH 3,927 WAYS.

See more on page 142.



WE ONLY USE GREEN PAINT.

Every single one of our meticulously selected range of 21 paint colours is water-based.

That means they don't crack, and they last longer without fading.

But above all they're far better for the environment. Everyone's a winner.





FLUTE
IVORY

Square framed door with a grooved centre panel in a smooth ivory finish.

TRADITIONAL



**EDWARDIAN
PAINTED**
LIGHT GREY

In-frame effect door in a smooth painted finish.

21 PAINTED COLOURS
See page 144 to see our full palette.



TRADITIONAL

**MINSTER
PAINTED**
BLUSH & SLATE

Shaker style door featuring an inner
beading with a smooth painted finish.

21 PAINTED COLOURS
See page 144 to see our full palette.





**FRAMED
PAINTED
IVORY**

In-frame door featuring a painted solid ash frame and veneered centre panel.



21 PAINTED COLOURS
See page 144 to see our full palette.



**SCULPTURED
PAINTED
CASHMERE**

Solid timber painted square framed door
with a raised centre panel.



21 PAINTED COLOURS
See page 144 to see our full palette.



SHIRES PAINTED LIGHT BLUE & WHITE

In-frame door featuring a foil wrapped painted woodgrain effect finish.

21 PAINTED COLOURS
See page 144 to see our full palette.



136



REGENT IVORY

Square framed door with a raised centre panel
in a smooth Ivory finish.

137



ENDLESS POSSIBILITIES

Every choice of worktop, door handle and light fitting takes your kitchen one step closer to becoming your own. Explore the endless possibilities.

OPTIONS

DOOR COLLECTION [140](#) PAINTED OPTIONS [144](#) CABINETS [146](#)
DRAWERS [148](#) HANDLES [150](#) SINKS [152](#) TAPS [153](#) WORKTOPS [154](#)
LIGHTING [158](#) DESIGN FEATURES [164](#) ORGANISATION [168](#)
CLEVER STORAGE [170](#) PLANNING [174](#) FAQs [176](#) INDEX [177](#)
KITCHEN SPECIFICATIONS [178](#)

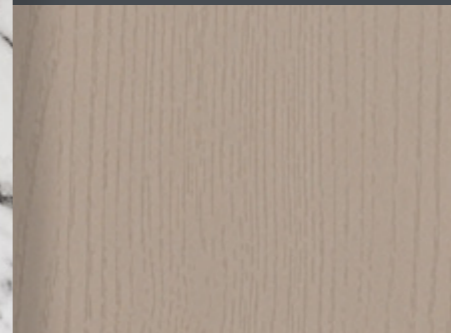
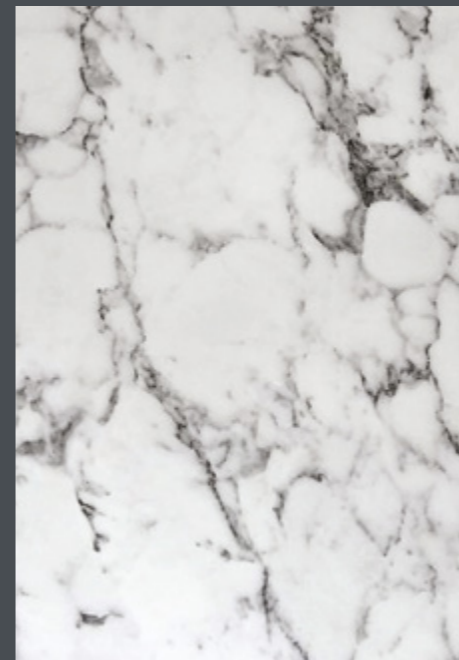

DOOR COLLECTION

The door style can define the whole look and feel of your new kitchen. That's why we've created a door range to suit every kind of home and every kind of taste.

21 PAINTED COLOURS
See page 144 to see our full palette.

MODERN DOORS



LINEAR BELLATO GREY CHIC IVORY CHIC LIGHT GREY CHIC LIMESTONE CHIC DARK BLUE CHIC FJORD

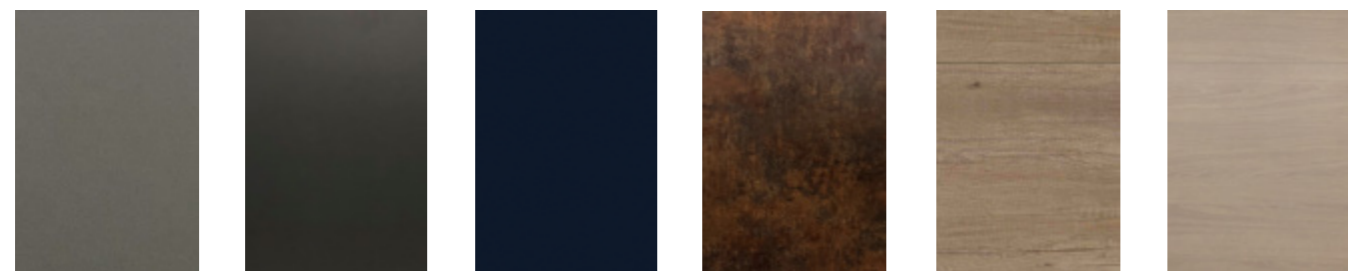

CHIC DUSK GREY CHIC GRAPHITE CHIC DARK BLUE CHIC COPPER LINEAR NEBRASKA OAK LINEAR SAND OAK



LINEAR LISSA OAK LINEAR DRIFTWOOD LINEAR BROWN GREY AVOLA LINEAR BARDOLINO OAK LINEAR ATRIUM GREY LINEAR NEW ENGLAND OAK

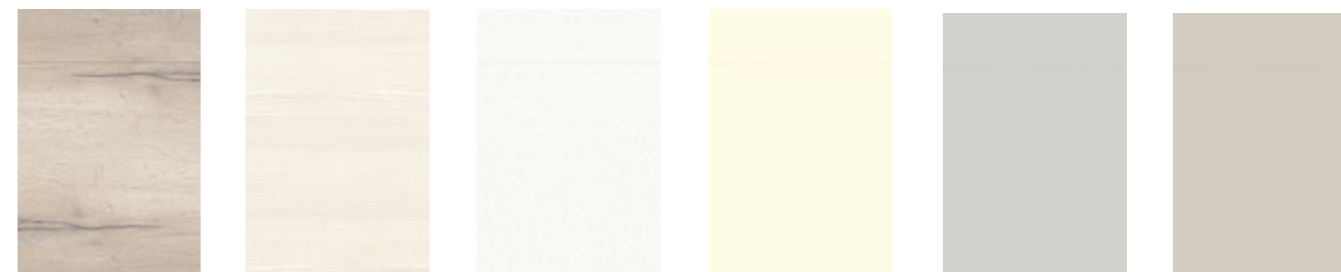

LINEAR WHITE OAK LINEAR WHITE AVOLA SHEER GLOSS WHITE SHEER GLOSS IVORY SHEER GLOSS LIGHT GREY SHEER GLOSS CASHMERE



SHEER GLOSS LIMESTONE FRESCO LIGHT GREY FRESCO TRUFFLE FRESCO CASHMERE FRESCO IVORY FRESCO ANTHRACITE



LINEAR SATIN WHITE METRICA GLOSS STONE METRICA GLOSS IVORY METRICA GLOSS WHITE METRICA GLOSS GREY METRICA GLOSS CASHMERE

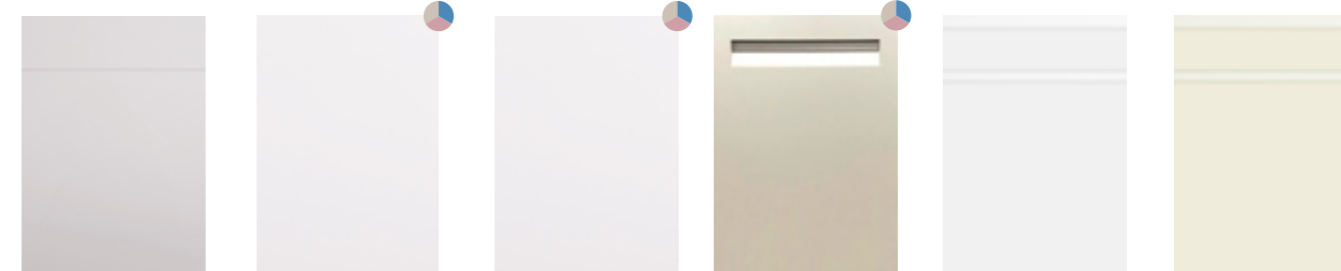

METRICA GLOSS LIGHT GREY OBLIQUE GLOSS WHITE & PAINTED LINEAR PAINTED AUTOGRAPH PAINTED INTEGRAL GLOSS WHITE INTEGRAL GLOSS IVORY

MODERN DOORS



INTEGRAL GLOSS
GREY

INTEGRAL GLOSS
CASHMERE

INTEGRAL GLOSS
LIGHT GREY

INTEGRAL GLOSS
ANTHRACITE

INTEGRAL GLOSS
LIMESTONE

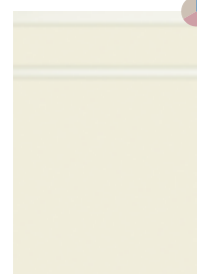

INTEGRAL PAINTED



LINEAR LUSTRE
METALLIC

TRADITIONAL DOORS



REGENT IVORY

FLUTE IVORY

MINSTER

MINSTER PAINTED

PAINTED IN-FRAME



EDWARDIAN PAINTED



CHARACTER PAINTED



MANOR HOUSE
PAINTED



WOOD FRAMED
PAINTED



HARMONY PAINTED

SHAKER DOORS

OPTIONS



TIMBER
LISSA OAK

SAND OAK
FOIL SHAKER

TREND
IVORY

NOUVEAU
WHITE

NOUVEAU
IVORY

NOUVEAU
LIGHT GREY



NOUVEAU
CASHMERE



IVORY
SHAKER



NOUVEAU
PAINTED



TREND
PAINTED

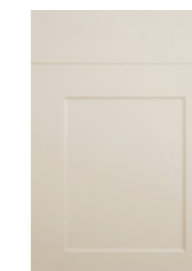

GLOSS STONE
SHAKER

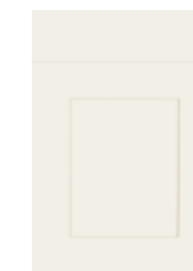

TIMELESS
PAINTED

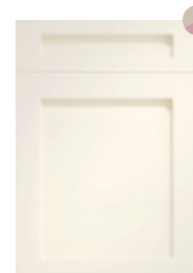

SAVOY
PAINTED

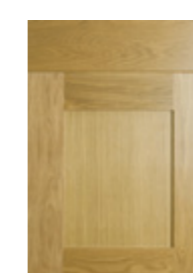

TIMBER LISSA OAK
SHAKER



TIMBER SAND OAK
SHAKER



INTEGRAL SHAKER
GLOSS WHITE



CHAMFERED
PAINTED

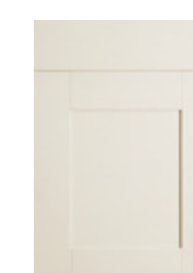

PAINTED TIMBER
SHAKER

21 PAINTED COLOURS
See page 144 to see our full palette.

PAINTED OPTIONS

Express your own unique style. Mackintosh kitchens are available in 21 stunning, on-trend colours.

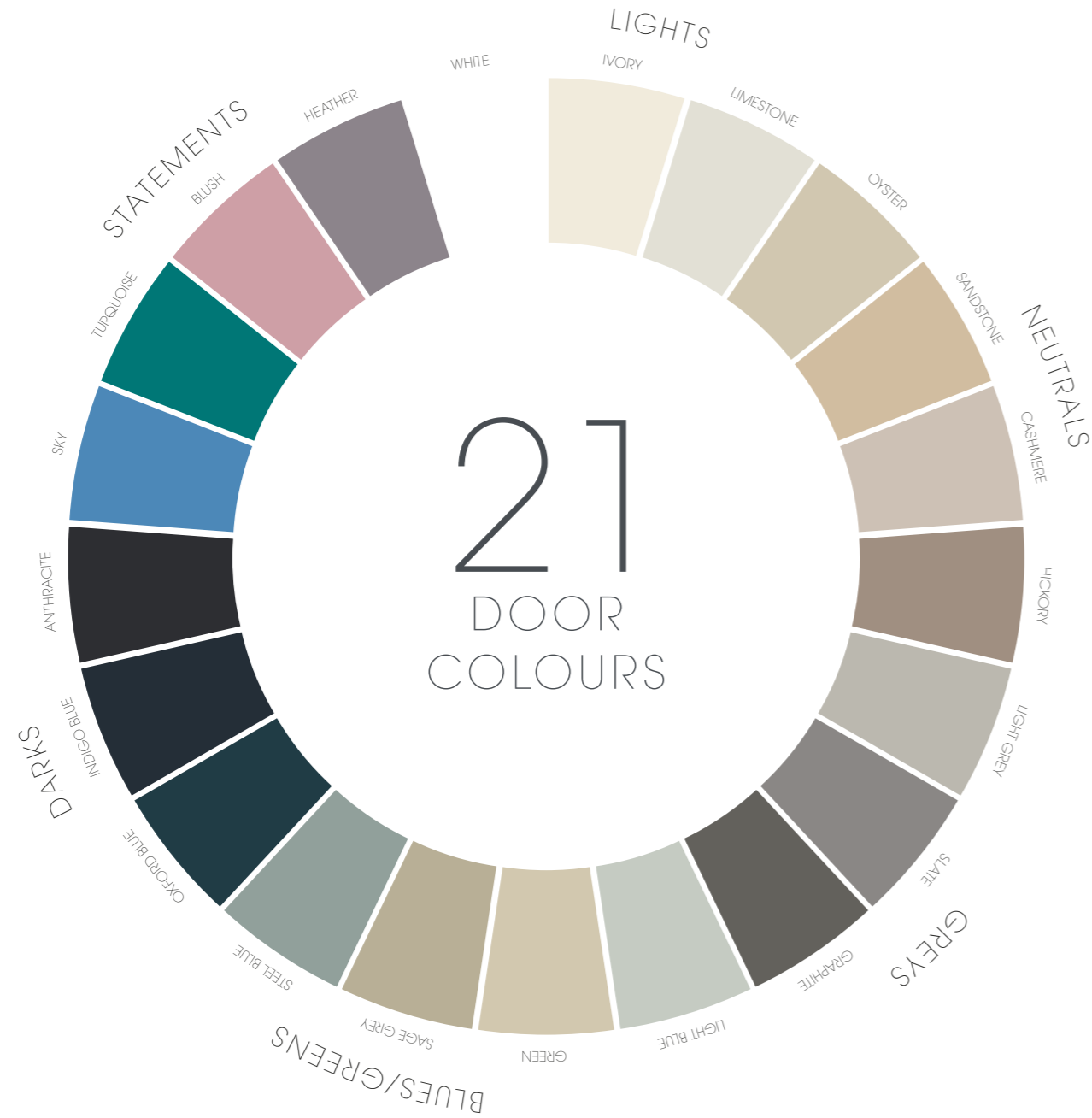

The colours shown in this brochure are as accurate as the printing process allows and therefore we strongly recommend that you contact your Mackintosh retailer to view a display or door sample before placing your order.

THE PAINTED COLLECTION

OPTIONS

Our eclectic range of 17 door styles span the entire history of cabinet design, from the decorative bevelling of Minster to the sleek minimalism of Autograph. Each of these designs is available in all 21 of our paint colours, so you're free to pair classic style with a contemporary palette.



COLOUR COMBINATIONS

With such a range of colours to choose from, it can be hard to settle on a scheme – so for inspiration below we've provided a few examples of core colours and complementary accents. Whether you opt to accent your base or wall units is up to you, but even subtle accenting can bring real drama to your space.

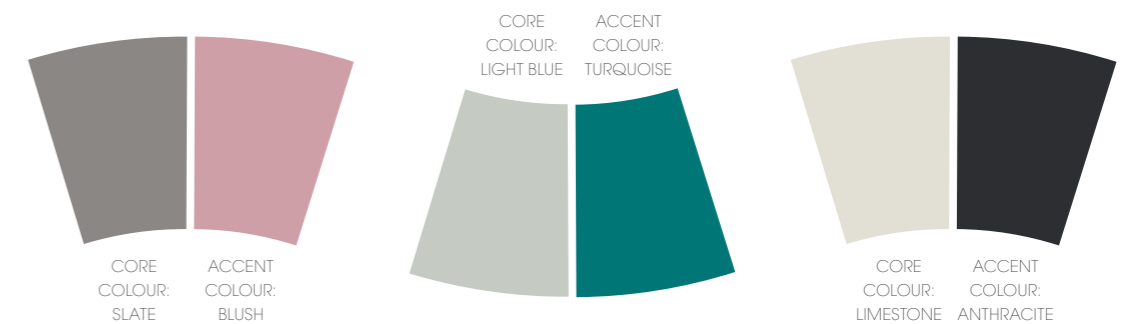

CABINET SPECIFICATION

All our cabinets are made to the highest standards of British manufacturing. They're pressed together under pressure-controlled conditions to ensure they're perfectly square and totally rigid. They also have solid back panels, no visible screws or fixings and are fully edged to protect against moisture, even on the edges you can't see.

All this simply means that your only worry when choosing your cabinets is what they bring to the style of your kitchen. Do you want the warmth of natural wood or the elegance of a gloss finish?

Extra features like adjustable shelving, soft-closing hinges and anti-tip fittings make your cabinets unique.



ALL OF OUR CABINETS COME WITH THE BELOW AS STANDARD:

- Adjustable shelf positions
- Fascias can be adjusted in multiple directions to align the doors
- Choice of depth – 300mm or 350mm units
- Choice of height – 576mm, 720mm or 900mm
- Customisable shelf position in double-width units, thanks to a divisional panel in the centre of the unit
- Adjustable legs for fitting base units on uneven floors
- Glass shelves as standard for glazed units
- 50mm service void for ease of maintenance

COLOUR CO-ORDINATED CABINETS

You can choose to contrast or blend your cabinet colour with the doors and drawer front, for no extra cost. We offer a range of 11 cabinet finishes in different colours. Matching plinths and frontals, panels and pilasters help you to complete the theme.



PLATINUM WHITE



MATT IVORY



MATT CASHMERE



ALUMINIUM



GLOSS IVORY



GLOSS CASHMERE



GLOSS STONE



GLOSS WHITE



LISSA OAK



SAND OAK



GRAPHITE (FULLY CO-ORDINATED)

Graphite cabinets can be matched with graphite frontals, drawers and wirework for a fully co-ordinated look.

Go to page 172 to view our clever storage solutions in graphite.

GRASS® SCALA STONE & NOVA PRO

Mackintosh kitchens proudly use drawer boxes by GRASS®, a world-class supplier of quality drawer systems. With silky smooth runners and perfect alignment, GRASS® drawers make accessing your kitchen goods a joy. All drawer systems arrive pre-fitted, saving time and money on installation.



GRASS® SCALA STONE



LUXURY OAK DRAWER BOXES

Superior solid oak drawer boxes bring a touch of craftsmanship to your kitchen. These are available in both drawer boxes and pan drawers, held together with a traditional dovetail joint, and fitted with GRASS® soft-close runners. Oak pairs especially well with painted ranges.



GRASS® SCALA STONE & NOVA PRO ALUMINIUM DRAWER FEATURES

- **Ultra-smooth** – Fully synchronised drawer runners open smoothly and with low force
- **Soft-close** – Smooth and silent action prevents slamming of drawers
- **Strong** – Full extension runners mean load-bearing capacity is 40kg (more than conventional drawer systems)
- **Spacious** – More storage space provided by twin-wall, metal-sided drawer box with straight internal sides
- **Solid base** – A 16mm base delivers extra rigidity and reliability
- **Easy-clean** – Tool-free removal of the drawer and drawer front make thorough cleaning hassle-free



GRASS® SCALA STONE (with square side profile). Supplied as standard.



GRASS® NOVA PRO ALUMINIUM (with curved side profile). Supplied as a free-of-charge option.



GRASS® SCALA STONE Pan Drawer with Rails



GRASS® NOVA PRO Drawer with Rails

SMOKED GLASS & CRYSTAL GLASS PAN DRAWER SIDE OPTIONS

Pan drawers are the solution to messy cupboards when it comes to keeping the kitchen sleek and tidy. The traditional railings allow pan handles to protrude, sometimes making it a struggle to close drawers properly. That's why, as well as railings, we offer the alternative option of smoked* or crystal glass sides. Available free of charge as an optional extra, this chic solution helps keep your pan drawers closing perfectly.



GRASS® SCALA STONE Pan Drawer with Smoked Glass



GRASS® NOVA PRO Drawer with Crystal Glass

*Smoked Glass is only available with Scala whilst Clear Glass is only available with Nova Pro.

HANDLES

It's amazing the difference that good handle selection can make to the overall finish of your kitchen. Personalise your Mackintosh kitchen with our wide range of stylish and practical options.

OPTIONS

MODERN



TRADITIONAL



Please note, not all handles are suitable for each kitchen. Most are supplied at no extra charge, however some premium options do carry a surcharge. Your Mackintosh retailer will happily advise you on suitability and cost. All handles are fitted vertically unless specifically stated.

* Handle suite carries a surcharge. ** Handles fitted horizontally.

SINKS

It's where potatoes are peeled for a hearty Sunday roast. It's where little hands are rinsed after dipping into the cake mix. And it's where your best plates – the ones too delicate for the dishwasher – are washed up ready to entertain guests another time.

That's why we take our sinks seriously. Mackintosh's sleek stainless steel products are made of the highest grade steel available, which is resistant to staining, rusting and corrosion.

Our HYDRA ceramic sinks come in different colours, from black to white, for a striking impression or a classic style. But looks aren't everything: the 80% quartz granite also has anti-bacterial properties, as well as being resistant to heat, burns and stains.



HYDRA 1.0 BOWL (WHITE) HYDRA 1.5 BOWL (WHITE)
 HYDRA 1.0 BOWL (GREY) HYDRA 1.5 BOWL (GREY)
 HYDRA 1.0 BOWL (BLACK) HYDRA 1.5 BOWL (BLACK)



LIBRA 1.0 BOWL SMALL LIBRA 1.0 BOWL LIBRA 1.5 BOWL MERCURY 1.0 BOWL MERCURY DRAINER SATURN 1.0 BOWL UNDERMOUNT
 SATURN 1.5 BOWL UNDERMOUNT NOVA 1.0 BOWL UNDERMOUNT SMALL NOVA 1.0 BOWL UNDERMOUNT LARGE NOVA 1.5 BOWL UNDERMOUNT PLUTO 1.0 BOWL (REVERSIBLE)
 PLUTO 1.5 BOWL (REVERSIBLE) EUROPA 1.0 BOWL COMPACT EUROPA 1.0 INSET BOWL EUROPA 1.5 INSET BOWL TITAN 1.0 INSET BOWL
 TITAN 1.0 INSET BOWL COMPACT TITAN 1.5 INSET BOWL BELFAST 1.0 BOWL SINK (WHITE) PORTLAND 1.0 BOWL PORTLAND 1.5 BOWL

TAPS



CHARON CHROME CHARON BLACK CHARON GREY CHARON BRUSHED CHARON WHITE
 ELARA CHROME VESTA CHROME LIBERTY CHROME SWAN CHROME* EVA BRUSHED***
 ERIS BRUSHED*** IDA BLACK IDA BRUSHED IDA CHROME IDA GREY
 IDA WHITE LEDA CHROME LEDA BLACK LEDA BRUSHED LEDA GREY
 LEDA WHITE CORA BRUSHED*** COX CRUCIFORM CHROME** FLEXIO CHROME† U NECK SINGLE LEVER CHROME

* Ideal for mounting on a solid surface such as wood or granite. * No diffuser supplied. ** Requires a minimum 5 metre head or pressured system. *** Also available in Chrome. All taps are WRAS approved except: Liberty, Swan, Cox Cruciform and Flexio.

WORKTOPS

Our eclectic range of 60 luxurious worktop finishes gives you complete creative control over the base tones and textures that will govern the feel of your new space. Bring natural depth and warmth with Dark Mountain Oak, or classical opulence with the Italian-inspired marbling of Nero Portoro.

We use the highest quality Duropal laminates, which allows us to alleviate your worries regarding sunlight damage, scratching, abrasion, coffee stains, tea stains, red wine, ink, fruit juice and cigarette burns. No surprise that Duropal hold the FIRA Gold Award for product excellence.



THE CUTTING EDGE

Our worktops are available in both Quadra (rounded) and Square edge profiling. Square is the more versatile, available in 40mm, 22mm and 12mm compact in addition to curved surfaces. Quadra is available in 40mm (with 4 options in 20mm) on straight surfaces. Quadra edging features 'seal-groove' technology that protects from a lifetime of steam and moisture damage.



AHEAD OF THE CURVE

Improve the flow of your workspace with curved base ends and corner units, topped by meticulously designed curved worktops, available in square edged 40mm and 22mm, in all colours.

GABLE ENDS

Elevate your surface spaces with a raised gable end, the perfect place to share cocktails with friends and tidy away the barstools when you're done. Available in square edged 40mm and 22mm, in all colours.



40MM & 22MM

OPTIONS

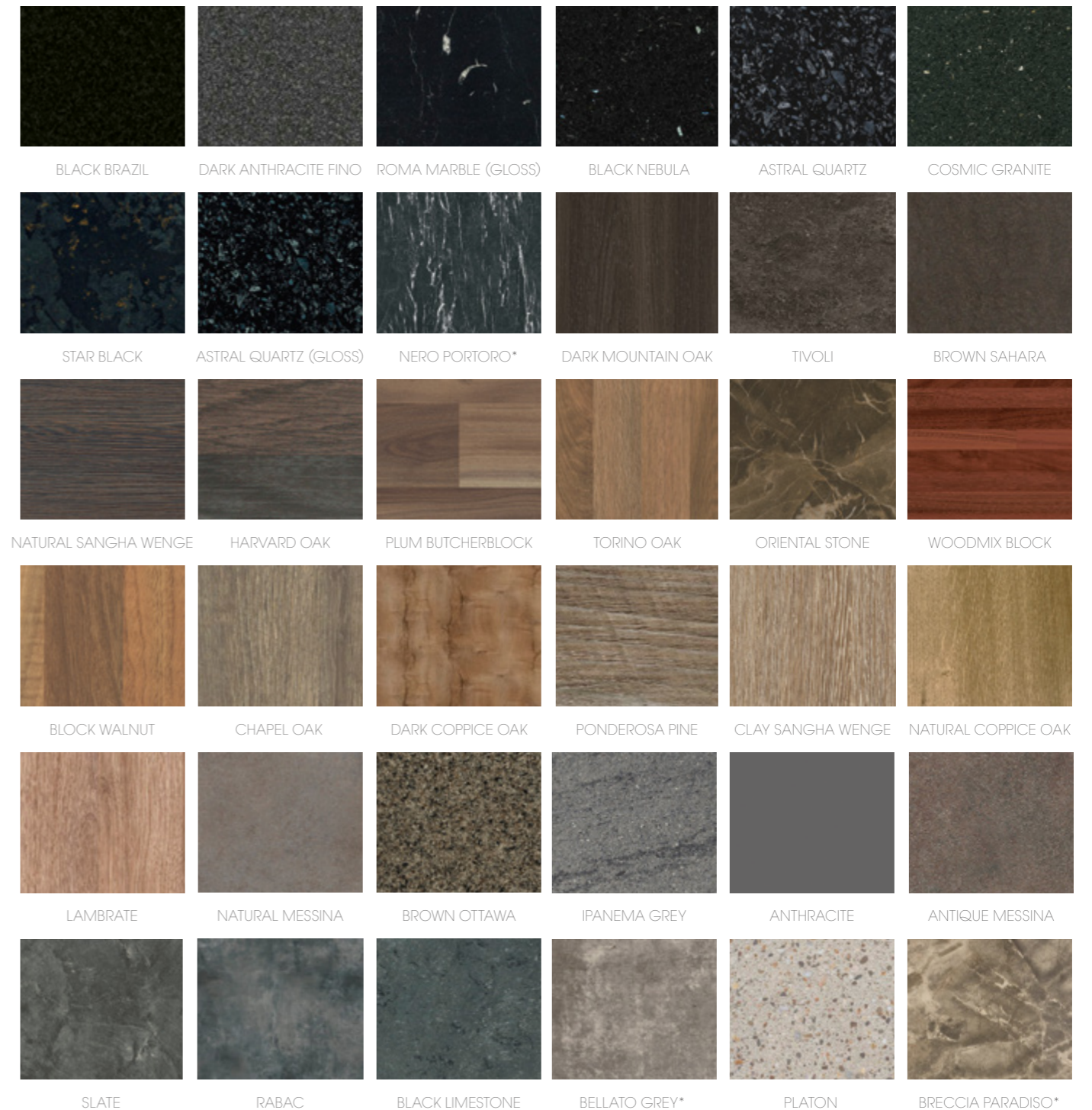

40MM & 22MM



12MM COMPACT

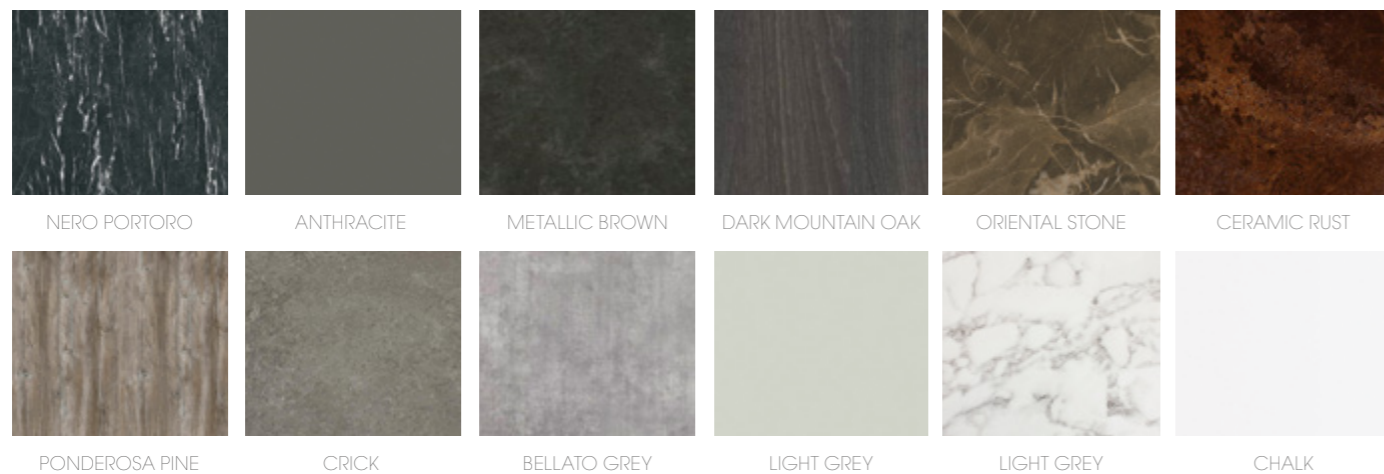

OPTIONS

BACKBOARDS & UPSTANDS

Available in all colours, splashbacks and upstands are an ideal alternative to tiling, protecting walls from splashes behind hobs and sinks. Available in all 60 colours of our core worktop range.



FOR MORE INSPIRATION, PLEASE VISIT

mackintoshkitchens.co.uk

*Available in 20mm quadra profile

LIGHTING

Lighting makes all the difference. From strip lights to drawer lights, from table lights to floating shelves, and from cabinet lights to sensor lights, we know exactly how to bring your brand-new kitchen to life.

OPTIONS

UNDER CABINET STRIP LIGHTING



Strip Light in sizes 222, 343, 525 and 904mm
Code: LTLED 222, 343, 526 or 904

IN CABINET LIGHTING



Sensor Lighting in sets of 2 or 3
Code: LTSEN2 or 3

FLEXIBLE STRIP LIGHTING

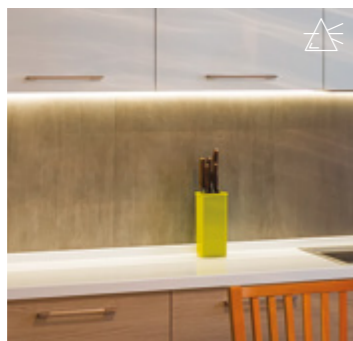

3m Bendable Strip with solid light
Code: LTBND3



2m Flexible Strip with high output
Code: LTFLEXHP



SIGMA Flexible Bendable Strip Light
5m length Code: LTFX5

UNDER CABINET LIGHTING



NOVA Rechargeable Unit Light
Code: LTCHRG

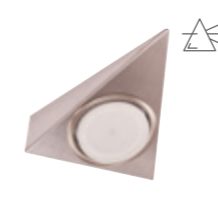

60 POINT Triangular Light
Code: LTTRI60

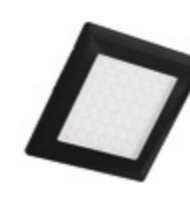

ALPHA Square Light in Black in sets of 2 or 3
Code: LTASQ 2BL OR 3BL



ALPHA Rectangular Light in Black in sets of 2 or 3
Code: LTARC 2BL OR 3BL

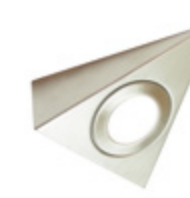

CAPELLA Triangular Light
Code: LTCAPELTRI



CAPELLA Round Light
Code: LTCAPELLA

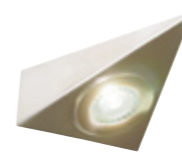

POLARIS Triangular Light
Code: LTTRIPOL2



POLARIS Round Light
Code: LTRNDPOL2



SIRIUS Tablet Light in sets of 2 or 3
Code: LTTAB 2 or 3



SIRIUS Magnetic Round Light in set of 2
Code: LTSDL2



SOLARIS Square Light in sets of 2 or 3
Code: LTDSQ 2 or 3



SOLARIS Square Light in sets of 2 or 3
Code: LTSOLSQ 2 or 3



SOLARIS Rectangular Light in sets of 2 or 3
Code: LTDRC 2 OR 3



SOLARIS Rectangular Light in sets of 2 or 3
Code: LTSOLRC 2 OR 3



VEGA Triangular Light in sets of 2 or 3
Code: LTVTRI 2 or 3



VEGA Round Downlight in set of 2
Code: LTVDL2

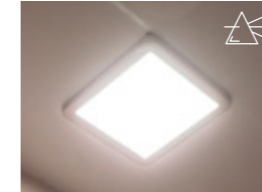

VEGA Square Downlight in set of 2
Code: LTVSQ10

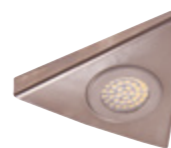

HALO Triangular Light in set of 2
Code: LTHALTRI2



HALO Round Light in set of 2
Code: LTHAL2

DRAWER LIGHTING



Drawer Light to fit in 500,600,800,900mm drawers
Code: LTDRW50/60/80/90/100

PLINTH LIGHTING

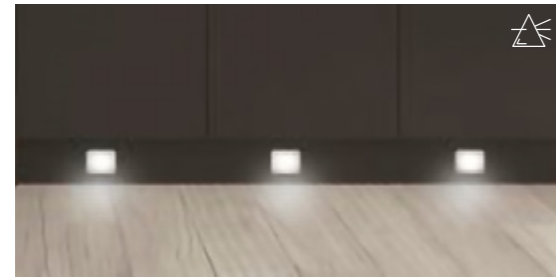

VEGA Square Plinth Light set of 4
Code: LTVPL4



VEGA Round Plinth Light set of 4
Code: LTVRND4

SHELF LIGHTING



SIRIUS Floating Shelf Light
in sizes 600 or 900mm
Code: LTSHELF 60 or 90



TORINO Black Lit Shelf
in sizes 600 or 900mm
Code: LTBXS 60BL or 90BL



Glass Shelf Strips LED Light
in pack of 2 strips 500mm unit
Code: LTSHLED2

SOCKETS & SWITCHES COLLECTION

OPTIONS



1
Touch Dimmer Switch
Code: LTDIM



2
Infra Red Door Sensor
Code: LTDRSWITCH



3
Infra Red Swipe Sensor Switch
Code: LTIRSWITCH

1. The touch dimmer offers a simple plug and play connection system, so a maximum of 6 lights can be controlled from a single switch.
2. Switch is designed to work by automatically turning a light on or off when a door is opened or closed.
3. Allows lights to be controlled by a swipe of the hand.

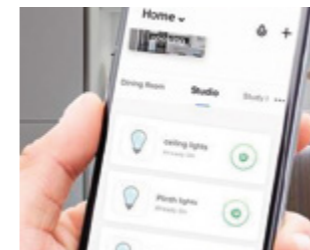

Wireless Kinetic System for Smart Devices
Code: LTKINREC

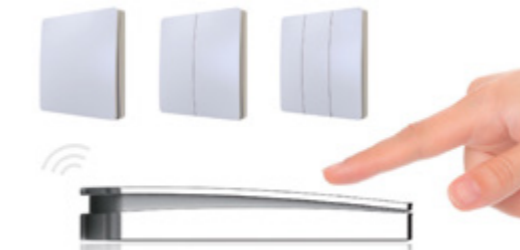

Wireless Kinetic Switch in 1, 2 or 3 gang
Code: LTKINS 1, 2 OR 3

The Wireless Kinetic Switch System doesn't use batteries or wires and allows you to control the lights by hand using the wireless switch, from a smart device or through voice-controlled systems.



Motorised Pop up Socket with 2 USB pins and wireless charger.
Available in Black or Silver.
Code: LTQISK BL or SL



Pop up Socket with 2 USB pins.
Available in Black or Silver
Code: LTSKT BL or SL



DESIGN YOUR NEW KITCHEN IN THE
COMFORT OF YOUR OWN HOME.

mackintoshkitchens.co.uk/visualiser

SOFTLY
SOFTLY

A detailed, technical illustration of a GRASS Tiomos hinge mechanism. It shows the internal components, including the mounting plate, the hinge arm, and the soft-close damper. The illustration is rendered in a light grey color against the dark background.

We are the only major kitchen manufacturer to use premium GRASS® Tiomos hinges with easy adjustment and simple safety features. With a soft close this smooth, you could find yourself opening a door just to enjoy watching it close.

Nothing could be more enjoyable than selecting the individual features that help set your new kitchen apart from the rest. Mackintosh serves up a whole menu of different design options to choose from. Combine stylish touches and practical innovations to achieve the customised result you deserve.



WALK-IN CORNER LARDER STORAGE

Corner cupboards are tricky things. While there's plenty of space in there to store foodstuffs, the depth means that all too often items get hidden, lost or forgotten. With that in mind, we designed our walk-in corner larder unit, with fully accessible storage and even a full-height wine rack.

Or you might choose the standard corner larder unit which also provides easy access and includes four Kessebohmer LeMans storage systems.



USING UNITS DIFFERENTLY

It's time to take a fresh look at kitchen units. With Mackintosh you can create your very own unique design. For example, you could take a humble bridging unit and combine it with open plan shelving, creating a whole new design feature that's practical as well as attractive.

DRAWER OPTIONS

You might never have thought about it, but the way kitchen drawers are arranged – as well as their number – can differ from kitchen to kitchen. The right configuration of deep pan drawers⁽¹⁾, contrasted with shallower top drawers⁽²⁾, will deliver the best storage and visual effect for your kitchen. Your Mackintosh dealer will be happy to help you find the perfect fit.

(1)



(2)



L-SHAPE CORNER UNITS

Specially designed to get the most out of these hard-to-reach spaces, our L-shape corner units are available in different sizes and are ideal for everyday accessible storage.



GLAZED UNIT

It's time to turn your wall units into eye-catching features. With one of our glazed wall unit designs, you can turn a cupboard door into a cupboard window. Not only does this add a touch of chic, it also saves you opening every cupboard to check what's inside.

CHUNKY PILASTER

Add elements of traditional flair such as pilasters, small pillars that work perfectly with a Mackintosh kitchen. This means you can take complete control of building the right look and feel for your space.



LARDER UNITS WITH OAK DRAWERS

Few things beat the dignified beauty of real oak. That's why, for our larder and pantry unit options, exquisitely crafted oak drawers are available in a variety of heights and styles. Experience the satisfaction of good taste each time you reach for a jar or a ramekin.



WORKING MANTEL

Give your space the solid respectability of a Victorian kitchen with an attractive mantel. Select from an array of veneered and painted finishes, then enjoy the extra storage as well as the vintage vibes.

LIFT UP WALL UNITS

Sometimes you need access to a storage space for longer, for example while cooking. But leaving cupboard doors open is unsightly and unsafe. Enter the lift-up wall unit. This flap door opens upwards and remains open until you're ready to close it. Built-in soft-close technology means you'll never have to hear it slam.



CURVED CORNER UNIT

This sophisticated approach removes the angles from corners and adds a sweeping line instead, with a curved door that will suit both contemporary and traditional interiors. Pairing perfectly with curved laminate worktops, curved corner units are available with these kitchens: Integral* (all colours), Timeless (all colours), Chamfered (all colours), Sculptured (all colours), Manor House (all colours), Trend (all colours).

*Please note the curved unit used for Integral ranges is supplied with two doors

WICKER BASKETS

For a real rustic touch, we recommend wicker basket storage. As base units they are ideal for larder-style storage, and the soft materials will add a note of warmth and tradition to your new kitchen.



ORGANISATION

Mackintosh kitchens are as practical as they are beautiful - with a range of functional accessories, they are available, especially designed to allow you to customise your kitchen to your exact needs.

A wide range of cutlery trays and utensil dividers are available in either a plastic or luxurious oak finish. Combinations of trays and dividers are used depending on the width of the drawer and your Mackintosh retailer will be able to advise you on the possible combinations.

- 1. Oak cutlery drawer inset
- 2. Cutlery inset with foil dispenser, knife block and glass pot accessories



LINERO MOSAIQ MIDWAY SYSTEM

This stylish and functional midway rail system is supplied in one handy pack and features two 600mm rails, shelf, pot (with quiver), two utensil hooks and kitchen roll holder ensuring useful items are always to hand.



OPTIONS



- 3. Pull-out bin units
- 4. Swing-out removable recycling bins
- 5. Pull-out combi waste bin
- 6. Swing-out cylinder waste bin
- 7. Rectangular waste bin

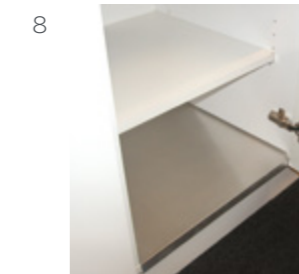

- 8. Drip tray
- 9. Pull-out towel rail and tray space
- 10. Removable oak storage boxes and removable oak pegs to keep crockery secure.



CLEVER STORAGE

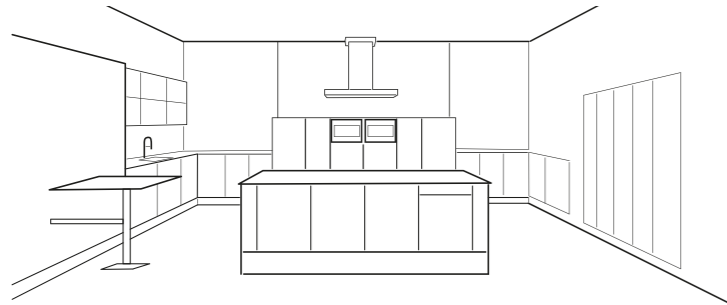

Making your new kitchen as functional as it is attractive

During the kitchen planning process it's useful to imagine not just how you'd like the space to look, but just as importantly, how you typically use your space every day; Where are the pots and pans kept? How easy is it to see the contents at the back of my shelves? Can I actually reach every area of my cabinets, or am I planning wasted space?

All of our kitchens come with the optional addition of Clever Storage products from Kesseböhmer; the best of German engineering that means your new kitchen design won't just look great, but will make time spent unpacking shopping, preparing meals, and tidying up both quick and easy.



1



2



3



4



OPTIONS

1. DISPENSA - Remarkably tidy storage space. The trays can be individually hung at heights to suit the contents, making DISPENSA a flexible solution providing a lot of storage with a very small footprint.
2. DISPENSA SWING - This supply cabinet that's really got that swing! When it is fully pulled out, it can be rotated 90° on its own axis so that either side can be turned to the front as required.
3. DISPENSA JUNIOR - Wave goodbye to waste. Slim base cabinets are notorious places for food which stays hidden until it's no longer edible. The DISPENSA Junior allows for instant visibility and access to all areas of the unit in one motion.
4. CONVOY PREMIO - creates an emotional connection when you open or close it: The contents glide out of the cupboard, moving directly towards you so that you can reach them from three sides. With CONVOY Premio stocking up on food becomes a real adventure.

Products are available in both matt silver and anthracite.

CLEVER STORAGE

- 5. **IMOVE** - The intelligent pull-down system for wall units. Having wall units in your new design doesn't have to mean balancing on a chair or keeping a step stool handy; the iMove allows for easy accessibility to difficult to reach spaces, meaning wall cabinets can be fully utilised by everyone in the household.
- 6. **LEMANS** - Easy Accessibility is just around the corner. If you're planning an "L" or "U" shaped kitchen then you will need to tackle the tricky corner space which will otherwise be wasted. With height adjustable trays that each pull completely out of the cabinet individually and boast a market leading weight and size capacity, the Kesseböhmer LeMans is the world's best-selling corner solution.



reddot design award

Experience the design every time you reach for a pot or pan with the LeMans Corner Storage system, awarded the Red Dot Design for outstanding design achievements.

5



6



172

7



8



9



OPTIONS

- 7. **NO. 15** - Extra storage space and functionality. With the right fitting, narrow gaps can provide a surprising amount of storage space and functionality.
- 8. **TANDEM SOLO** - The characteristic opening experience. One gentle pull opens the door and draws the fitting forward so that all the contents are in full view and easy reach.
- 9. **TANDEM ACCESS ALL AREAS** - No other solution gives you the same level of visibility and accessibility of your groceries. The Tandem Larder allows for storage of a whole week's of groceries in just one unit; so don't waste time searching through individual drawers, and don't waste money losing food at the back of your shelves until its past its best.

Products are available in both matt silver and anthracite.

173



PLANNING

As exciting as designing your kitchen can be, it's still an investment that needs care and consideration. Proper planning can result in a more functional, enjoyable space that stands the test of time.

Our trusted retailers are on hand to guide you through the process, but here's five things to think about before you begin.

1 LAYOUT

Take a look at your existing kitchen. How could the space be better used? Do any walls need to be knocked through? Take measurements wall-to-wall and come up with as accurate a floor plan as possible. Think about the appliances and features you'd like to include and how to arrange them, then bring your plans to one of our expert retailers.

2 EXPERTISE

A specialist will go through your plans with you and make sure you haven't overlooked anything. The last thing you want is doors knocking into each other, or areas of restricted movement. Less is more – prioritise space over features.

3 DOORS & WORKTOPS

Here's where the fun starts. Take a look at our extensive range of door styles, worktops and paint options. Experiment with texture and pattern, perhaps even contrast door colours between base and wall cabinets. Just remember to enjoy the process – play around and find what works for you.

4 STORAGE SOLUTIONS

We do storage differently. From our world of customisable organisation options to cutting-edge innovations from Kesseböhmer, including the award winning LeMans corner system – we make sure that even the most limited storage space is used optimally. Meaning your sides are always clear, and everything is where you want it to be.

5 FINISHING TOUCHES

Time to choose your door handles (unless you've gone handleless), sink and taps, lighting, drawers and design features. You can even start getting inspired about accessories – see our Instagram – but once you're happy with all of your choices, let our retailer know and we can start the ball rolling.

FAQS



You're bound to have some questions. To help you out we thought that we'd answer some of the more frequently asked ones. If your specific question isn't covered below, please just contact your approved Mackintosh retailer who will be sure to assist.

Where can I see displays of Mackintosh kitchens?

Just visit your local Mackintosh retailer to see a selection of our displays and a full set of doors. To fully appreciate the quality of our kitchens it's always better to see them in person.

Find your nearest Mackintosh retailer at mackintoshkitchens.co.uk/find-a-retailer

What's the difference between a true rigid cabinet and a flat-pack assembled cabinet?

All Mackintosh kitchen units are true rigid cabinets. They are assembled by skilled craftsmen in our factory, using the very latest technology. The difference between the two cabinets is that true rigid units are assembled using glue and dowel, rather than cam and dowel. This ensures a better overall finish as there are no visible fixings or redundant drill holes. All of our units have door, drawers and accessories pre-fitted.

Can I buy direct from Mackintosh?

Mackintosh kitchens are manufactured by Omega PLC and are only available via specialist retailers. This is to ensure specific knowledge is used to produce your ideal kitchen.

How long will it take for me to receive my Mackintosh kitchen?

Mackintosh kitchens will be delivered within 3 weeks from the order being placed by the retailer. Painted kitchens are available within 4 weeks from order placement.

What happens if I pay a deposit to a retailer for a Mackintosh kitchen and they cease trading before my kitchen is delivered?

This is unlikely, but we do run a Deposit Guarantee Scheme. This ensures that you'll still get your Mackintosh kitchen furniture at the current manufacturer's recommended retail price list, less the deposit paid on furniture. This is under the provision that the amount paid to the dealer doesn't exceed 50% of the manufacturer's recommended retail price.

Do your kitchens carry a guarantee?

All Mackintosh kitchens come with a 20 year guarantee on all cabinets, hinges and drawer boxes; a 15 year guarantee on doors and selected accessories. All products manufactured or supplied by Omega PLC will be free from defects in material and workmanship for the full duration of the guarantee, or else be replaced or repaired (at our discretion) free of charge. Subject to terms and conditions. Please see omegaplc.co.uk for full details

Do you charge for delivery?

All of our kitchens are delivered FREE* direct to your home and our two-man teams ensure your new kitchen is delivered with care and professionalism.

Are you KBSA accredited and what does that mean for me?

Yes, Mackintosh kitchens are KBSA accredited and dedicated to upholding the Association's high standards of design, supply, installation and customer service. All members follow an approved Code of Conduct and are subject to strict monitoring to make sure you get the best professional service available. For further information please visit kbsa.org.uk.

*Minimum order value applies



AUTOGRAPH PAINTED HEATHER & GRAPHITE	40	METRICA	
CHAMFERED PAINTED IVORY	106	Metrica Gloss Cashmere	62
CHIC		Metrica Gloss Light Grey	60
Chic Ivory & Cashmere	46	Metrica Gloss White	64
Chic Light grey	47	NOUVEAU	
Chic Limestone	47	Nouveau Painted Indigo Blue & Limestone	88
EDWARDIAN PAINTED LIGHT GREY	128	Nouveau White & Light Grey	92
FLUTE IVORY	126	OBLIQUE	
FRAMED PAINTED IVORY	132	Oblique Gloss White	22
FRESCO IVORY & TRUFFLE	74	Oblique Painted Sky & White	20
GLOSS STONE SHAKER	107	PAINTED WOOD SHAKER IVORY & HICKORY	104
HARMONY PAINTED TURQUOISE & HEATHER	118	REGENT IVORY	137
INTEGRAL		SAVOY PAINTED LIMESTONE & ANTHRACITE	98
Integral Gloss Anthracite	55	SCULPTURED PAINTED CASHMERE	134
Integral Gloss Cashmere	48	SHEER GLOSS IVORY	78
Integral Gloss Grey	56	SHEER GLOSS LIMESTONE	76
Integral Gloss Ivory	57	SHIRES PAINTED LIGHT BLUE & WHITE	136
Integral Gloss Light Grey	52	TIMBER	
Integral Gloss Limestone	54	Timber Lissa Oak Shaker	111
Integral Gloss White	50	Timber Sand Oak Shaker	110
Integral Painted Ivory & Green	58	TIMELESS PAINTED LIGHT GREY	100
Integral Shaker Gloss White	102	TREND	
INSET		Trend Ivory	96
Inset Chic Copper & Bellato Grey	30	Trend Lissa Oak	113
Inset Chic Fjord & Dark Blue	24	Trend Painted Sage Grey & Ivory	94
Inset Linear Lustre Metallic, Chic Graphite & Dusk Grey	26	Trend Sand Oak	113
Inset Linear Painted Limestone & Anthracite	28	WOODGRAIN ATRIUM GREY & CHIC GRAPHITE	44
Inset Metrica Gloss White	32	OPTIONS & ACCESSORIES	
IVORY SHAKER	112	Cabinets	146
LINEAR		Clever Storage	170
Linear Gladstone Oak	68	Design Features	164
Linear Sand Oak	70	Door Collection	140
Linear White Oak	72	Drawers	148
LINEAR PAINTED		FAQs	176
Linear Bellato Grey	82	Handles	150
Linear Painted Sage Grey & Ivory	80	Index	177
Linear Satin White	83	Kitchen Specifications	178
MANOR HOUSE PAINTED HEATHER, SLATE & LIGHT GREY	122	Lighting	158
MINSTER PAINTED BLUSH & SLATE	130	Organisation	168
		Painted Options	144
		Planning	174
		Sinks & Taps	152
		Worktops	154



KITCHEN SPECIFICATIONS

PRICE GROUP 0A

Range Name	Door Material	Lead Time	Curved Units	Available on Inset?
Chic (All doors)	Laminated MFC	3 weeks	No	Yes
Linear Bardolino Oak (Horizontal and Vertical)	Laminated MFC	3 weeks	No	Yes
Linear Bellato Grey	Laminated MFC	3 weeks	No	Yes
Linear Brown Grey Avola	Laminated MFC	3 weeks	No	Yes
Linear Driftwood	Laminated MFC	3 weeks	No	Yes
Linear Lissa Oak	Laminated MFC	3 weeks	No	Yes
Linear Nebraska Oak (Horizontal and Vertical)	Laminated MFC	3 weeks	No	Yes
Linear Sand Oak	Laminated MFC	3 weeks	No	Yes
Linear White Avola	Laminated MFC	3 weeks	No	Yes

PRICE GROUP 0B

Chic Copper	Laminated MFC	3 weeks	No	Yes
Fresco (All doors)	Laminated MFC	3 weeks	No	Yes
Linear Atrium Grey (Horizontal and Vertical)	Laminated MFC	3 weeks	No	Yes
Linear Gladstone Oak	Laminated MFC	3 weeks	No	Yes
Linear New England Oak (Horizontal and Vertical)	Laminated MFC	3 weeks	No	Yes
Linear White Oak (Horizontal and Vertical)	Laminated MFC	3 weeks	No	Yes
Sheer (All doors)	Laminated MFC	3 weeks	No	Yes

PRICE GROUP 1

Flute Ivory	PVC Wrapped MDF	3 weeks	No	No
Ivory Shaker	PVC Wrapped MDF	3 weeks	Yes	No
Linear Satin White	PVC Wrapped MDF	3 weeks	Yes	Yes
Nouveau (All doors)	PVC Wrapped MDF	3 weeks	No	No
Regent Ivory	PVC Wrapped MDF	3 weeks	No	No
Trend Ivory	Foil Wrapped MDF	3 weeks	Yes	No
Trend Lissa Oak	Foil Wrapped MDF	3 weeks	Yes	No
Trend Sand Oak	Foil Wrapped MDF	3 weeks	Yes	No

PRICE GROUP 2

Linear Painted	Painted MDF	4 weeks	Yes	Yes
Metrica Gloss (All doors)	PVC Wrapped MDF	3 weeks	Yes	Yes
Minster	PVC Wrapped MDF	3 weeks	No	No
Nouveau Painted	Painted PVC Wrapped MDF	4 weeks	No	No
Oblique Gloss White	Gloss Lacquered MDF	3 weeks	No	Yes
Oblique Painted	Painted MDF	4 weeks	No	Yes
Trend Painted	Painted Foil Wrapped MDF	4 weeks	Yes	No

PRICE GROUP 3

Autograph Painted	Painted MDF	4 weeks	No	No
Edwardian Painted	Painted MDF	4 weeks	Yes	No
Gloss Stone Shaker	PVC Wrapped MDF	3 weeks	Yes	No
Integral Gloss (All doors)	Lacquered MDF	3 weeks	Yes	No
Integral Painted	Painted MDF	4 weeks	Yes	No
Linear Lustre Metallic	Gloss UV Lacquered MDF	3 weeks	No	Yes
Minster Painted	Painted PVC Wrapped MDF	4 weeks	No	No
Savoy Painted	Painted MDF	4 weeks	No	No
Shires Painted	Painted Foil Wrapped MDF	4 weeks	Yes	No
Timeless Painted	Painted MDF	4 weeks	Yes	No

PRICE GROUP 4

Integral Shaker Gloss White	Lacquered MDF	3 weeks	Yes	No
Timber Lissa Oak Shaker	Solid Oak Frame with Veneered Centre Panel	3 weeks	Yes	No
Timber Sand Oak Shaker	Solid Oak Frame with Veneered Centre Panel	3 weeks	Yes	No

PRICE GROUP 5

Chamfered Painted	Painted Solid Ash Frame with Veneered Centre Panel	4 weeks	Yes	No
Manor House Painted	Painted Solid Ash Frame with Beaded Veneered Centre Panel	4 weeks	Yes	No
Painted Timber Shaker	Painted Solid Ash Frame with Veneered Centre Panel	4 weeks	Yes	No
Sculptured Painted	Painted Solid Ash Frame with Veneered Centre Panel	4 weeks	Yes	No

PRICE GROUP 6

Harmony Painted	Painted MDF	4 weeks	Yes	No
Framed Painted	Painted Solid Ash Frame with Veneered Centre Panel	4 weeks	Yes	No

MACKINTOSH®

mackintoshkitchens.co.uk